

COMMUNICATION NETWORK MANAGING SYSTEM, ELEMENT AND NETWORK MANAGERS THEREFOR, AND COMPUTER-READABLE RECORDING MEDIUM IN WHICH COMMUNICATION NETWORK MANAGING PROGRAM IS RECORDED

5

BACKGROUND OF THE INVENTION

1. Field of the Invention:

The present invention relates to a communication network managing system, an element manager and a network manager for use in the system, and a computer-readable recording medium in which a communication network management program is recorded.

2. Description of the Related Art:

Nowadays, a communication network is constructed using a variety of base technologies (transmission methods), such as SDH (Synchronous Digital Hierarchy), PDH (Plesiochronous Digital Hierarchy), ATM (Asynchronous Transfer Mode), WDM (Wavelength Division Multiplex) and IP (Internet Protocol). And the communication network is divided into subnetworks in a many variety of topologies, such as access networks, core networks, PDH networks and SDH networks. The communication network is thus complicated. Consequently these individual domains that constitute the communication network are managed by element managers or agents called EMSs (Element Management Systems),

Filed by Express Mail
(Receipt No. ELS92354KJ)
on 9/26/00
pursuant to 37 C.F.R. 1.10.
2502602

and these element managers are concentratedly managed by a network manager called NMS (Network Management System). Thus management of the whole communication network is accomplished .

5 In the conventional network management, however, partly because in the conventional connection-less network, such as IP network, QoS (Quality of Service) has not been guaranteed, and communication traffic running through plural domains depends on the QoS capability of those
10 domains, communication service guaranteeing the requested QoS cannot be provided until the requested QoS is satisfied in all the domains without exception.

For the same reasons, the user's requested QoS cannot also be sufficiently guaranteed by TV conference and voice
15 application for which guarantee of the request QoS is significant, and audio-visual (picture and voice) applications, such as Video on Demand, for which applications guarantee of the requested QoS is fairly significant, and other applications which need real-time
20 performance.

As a hypothetical attempt, collecting the individual QoS capability one for each of the individual units, through which communication traffic (user data) travels, by the above-mentioned element manager (EMS) and then selecting
25 a unit satisfying the requested QoS as an element through which communication traffic runs, could be suggested. But this would consume huge time to perform network control on

collected and notified by the individual element managers,
 and a request reception section for receiving a request for
 a target QoS capability, and a selection and notification
 section for selecting a candidate subnetwork having a QoS
 5 capability such as to satisfy the target QoS capability,
 for which the request has been received by the request
 reception section, based on the various QoS capabilities
 being managed by the management section, and for notifying
 the element manager corresponding the selected candidate
 10 subnetwork of selection information indicating that the
 candidate subnetwork has been selected; each element
 manager further having a control section for controlling
 the corresponding subnetwork based on the selection
 information notified by the selection and notification
 15 section of the network manager.

According to a second feature of the present
 invention, there is provided a system for managing a
 communication network composed of a plurality of
 subnetworks, comprising: a plurality of element managers
 20 provided one for each of the plural subnetworks for
 individual management thereof; and a network manager
 accommodating the plural element managers for concentrated
 management thereof; each of the plural element managers
 having a collection and notification section for collecting
 25 QoS (Quality of Service) capability management information
 on the corresponding element manager and notifying the
 network manager of the collected QoS capability management

information; the network manager having
a management section for concentratedly managing various
QoS capabilities of the whole communication network, based
on the QoS capability management information collected and
5 notified by the individual element managers.

According to a third feature of the present invention,
there is provided an element manager for use in a
communication network managing system, which manages a
communication network composed of a plurality of
10 subnetworks and includes a plurality of element managers
corresponding to the plural subnetworks and a network
manager accommodating the plural element managers, the
element manager comprising: a collection and notification
section for collecting QoS (Quality of Service) capability
15 management information to be used in managing the
corresponding subnetwork, and for notifying the network
manager of the collected QoS capability management
information; and a control section for controlling the
corresponding subnetwork based on information which is
20 obtained by the network manager having a function of
concentratedly managing QoS capabilities of the
communication network based on the QoS capability
management information collected and notified by the
collection and notification section and which is notified
25 from the network manager on the candidate subnetwork having
a QoS capability such as to satisfy a target QoS capability
for the corresponding subnetwork.

QoS stably at high speed, even in setting communication traffic via a plurality of subnetworks, without managing the QoS capability in units of the individual subnetwork managers.

5 As an additional feature to the fifth or sixth feature of the present invention, the management section is constructed to concentratedly manage the various QoS capabilities of the communication network and those of another communication network independent of the
10 last-named communication network in view of also QoS capability management information of other subnetworks that constitute the another communication network. With this construction, it is possible to select a subnetwork satisfying the QoS for another communication network

15 As another additional feature to the fifth or sixth feature of the present invention, the management section is constructed to manage supported tagging, as additional information, for discrimination on combination of the subnetworks. With this construction, it is possible to
20 facilitate discriminating the QoS capability with a combination of subnetworks, reducing time to select a subnetwork having a candidate QoS capability and to control the selected subnetwork.

 As still another additional feature to the fifth or
25 sixth feature of the present invention, the management section is constructed to update the various QoS capabilities of the communication network when the QoS

controlled, thus realizing a more stable network control satisfying the requested quality of service.

As an alternative additional feature to the fifth feature of the present invention, the selection and notification section is constructed to select two or more of the subnetworks according to preset priorities when selecting the candidate subnetworks having QoS capabilities such as to individually satisfy the target QoS capability, for which the response has been received by the request reception section, and to notify one element manager, corresponding to a higher-priority one of the candidate subnetworks, of the selection. With this construction, it is possible to realize a more stable network control satisfying the requested quality of service and to improve the quality of service so that the communication networks can be used efficiently.

According to a seventh feature of the present invention, there is provided a computer-readable recording medium in which a program is recorded for instructing a computer to be used in a communication network management system including a plurality of element managers corresponding to a plurality of subnetworks that constitute a communication network, and a network manager accommodating the plural element managers, wherein the program instructs the computer to function as the following: collecting and notifying means for collecting QoS (Quality of Service) capability management information

network, and a network manager accommodating the plural
element managers, wherein the program instructs the
computer to function as managing means for concentratedly
managing various QoS (Quality of Service) capabilities of
5 the network, based on QoS capability management information
of the corresponding subnetworks, which information has
been collected and notified by the individual element
managers.

10

BRIEF DESCRIPTION OF THE DRAWINGS

FIG. 1 is a block diagram showing a communication
network managing system according to a first embodiment of
the present invention;

15

FIG. 2 is a block diagram showing how a network manager
and an element manager (or agent) work in the system of the
first embodiment;

FIG. 3 is a detail block diagram of the system
according to the first embodiment;

20

FIG. 4 is a schematic diagram illustrating an
information object to be managed in the system of the first
embodiment;

FIG. 5 is a schematic diagram illustrating conditions
under which QoS (Quality of Service) of a subnetwork (or
25 domain) is determined in the system of the first embodiment;

FIG. 6 is a block diagram showing an example of
topology in which an access network is composed of ONU and

OLT in the system of the first embodiment;

FIG. 7 is a flow diagram illustrating the procedure in which QoS capability management information of the individual subnetwork is updated in the system of the first
5 embodiment;

FIG. 8 is a flow diagram illustrating how the system of the first embodiment works (QoS policy provisioning procedure);

FIG. 9 is a block diagram showing an alternative
10 communication network managing system according to a second embodiment of the present invention; and

FIG. 10 is a detail block diagram of the system according to the second embodiment.

15 DESCRIPTION OF THE PREFERRED EMBODIMENTS

Preferred embodiments of the present invention will now be described with reference to the accompanying drawings. Like reference numbers or characters designate
20 similar parts or elements throughout several views of different embodiments.

(A) First Embodiment:

FIG. 1 is a block diagram showing a communication network managing system according to a first embodiment of
25 the present invention. The managing system of FIG. 1 comprises a plurality of element managers or agents known as EMS (Element Management System) 2-i ($i=1, 2, \dots, N$)

corresponding to a plurality of domains (subnetworks) 3-1, 3-2, . . . , 3-N (N is an integer larger than 1) that constitute a communication network 4, and a network manager known as NMS (Network Management System) 1 accommodating these
5 element managers 2-i.

The individual domains 3-i have various technologies and/or topologies. For example, in FIG. 1, the domains 3-1, 3-N are in the form of access networks (ATM); the domain 3-2, in the form of a core network (SDH); the domain 3-3,
10 in the form of a core network (WDM). Thus this communication network 4 is constructed according to multiple technologies (topologies).

NMS 1 and EMS 2-i are in a manage-and-agent relationship as shown in FIG. 2. NMS 1 includes, as
15 managing objects 30, a function object group 31 for performing a control (QoS policy provisioning) over the communication network 4, and an information object group 32 for managing network information (QoS capability management information).

The information object group 32, as shown in FIG. 2,
20 is composed of various information objects, such as SN (Subnetwork), SNC (Subnetwork Connection), CTP (Connection Termination Point), TTP (Trail Termination Point), LND (Layer Network Domain), and Trail. The information object group 32 is provided for every layer, such as a VP (Virtual Path)/VC (Virtual Channel) layer in ATM or a VC (Virtual Container)/TU (Tributary Unit) layer in SDH.

These information object groups 32 are created based on the information objects (SN, SNC, CTP, TTP, etc.), which are under collection and management by EMS 2-i, upon notification from EMS 2-i. These information object groups 32 are managed by a common function object group 31 so that NMS 1 can select (network control, i.e. QoS policy provisioning) a domain 3-i, through which end-to-end communication traffic travels, such as to satisfy a requested QoS. Alternatively a plurality of function object groups 31 may be provided one for each of the plural information object groups 32.

The information objects (SN, SNC, CTP, LND, TTP, Trail) are network information such as illustrated in a more easily understandable manner in FIG. 4. SN is information identifying the domain (subnetwork) 3-i; SNC, information representing a path in SN; CTP, information indicating a joint of SN and SNC. And LND is information identifying a layer; Trail, information indicating an end-to-end path; TTP, information indicating a terminal end of Trail.

Among these information objects, LND and Trail cannot be grasped by EMS 2-i until after NMS 1 unifies the information objects (SN, SNC, CTP, TTP) notified from EMS 2-i.

NMS 1 and EMS 2-i will now be described more in detail. FIG. 3 is a detail block diagram of the managing system of FIG. 1. Each EMS 2-i includes a collection and notification section (collecting and notifying means) 5-i, and a control

section (control means) 6-i. NMS 1 in the meantime includes a management section (managing section) 7, a request reception (request receiving means) 8, and a selection and notification section (selecting and notifying means) 9.

5 The collection and notification section 5-i of EMS 2-i is equipped with a plurality of subnetwork resource configurators (SN-RC) 10 one for each of the layers that exist in the corresponding domain (whom EMS 2-i is in charge of) 3-i; the other collection and notifications 5-2, . . . ,
10 5-N are not illustrated in FIG. 3. These SN-RCs 10 serve to collect the above-mentioned information objects, as QoS capability management information, of the domain 3-i for each and every corresponding layer, and then to notify NMS 1 of the collected information objects.

15 At that time, the collection and notification section 5-i sends to NMS 1 only the information objects that are related to QoS capability of the whole domain. Assuming that, as shown in FIG. 5, a particular domain A is composed of two domains B and C, the collection and notification
20 section 5-i sends only the information objects about the AND condition of capabilities of the two domains B and C, namely, those about the QoS capabilities that can be supported by both of the domains B and C.

 In other words, at the domain B, the support target
25 pattern representing a QoS-guaranteeable target (kind) is "TOP (Type of Service)" and "Port" so that the requested QoS named "Peak Rate" can be guaranteed to the support

target pattern ("TOS" and "Port"). Meanwhile at the domain C, since the support target pattern is only "TOS" so that the requested QoS named "Peak Rate" and "Min Rate" can be guaranteed to "TOS", the AND condition of both the

5 information that the pattern of the QoS-guaranteeable target for the whole support domain A is "TOS" and the information that the support service quality is "Peak Rate", is notified to NMS 1 as the QoS capability of the domain A.

10 Like the collection and notification section 5-1 of NMS 2-1, each of the collection and notification sections 5-2, ..., 2-N of the other EMS 2-2, ..., 2-N has non-illustrated SN-RCs for every layer of the corresponding domain 3-i. These SN-RCs serve to collect information

15 objects of the corresponding domain and then to notify NMS 1 of the collected information objects.

Meanwhile, at NMS 1, the management section 7 includes, as function objects, a layer network model resource configurator (LN-RC) 11 and an end-to-end resource

20 configurator (E-RC) 12 (see FIGS. 2 and 3). LN-RC 11 configures a QoS capability layer NW view 42, which is to be used in managing the QoS capability of the individual domain, for every layer network, namely, for each of various technologies, such as access network (ATM), core network

25 (WDM) and core network (SDH), based on the information objects notified from SN-RC 10 of EMS 2-i.

And E-RC 12 configures an end-to-end QoS capability

NW view 43, which is to be used in managing the end-to-end QoS capabilities of the united all technologies, based on the network model (information model) of each technology of the QoS capability NW view 42.

5 If the communication network 4 is structured as shown in FIG. 1, the end-to-end QoS capability NW view 43 is composed of four domains, and QoS information of the individual domain is managed as an SN (Subnetwork) managed object as shown in

10 TABLE 1 below.

TABLE 1
SN MANAGED OBJECTS

SN-id	Supported Target Pattern	Supported Service Quality	Supported Tagging
1	Source-IP, Dest-IP	Peak Rate, Min Rate, BestEffort	Port:1
Domain 3-1	TOS, Port	Peak Rate, Min Rate, Priority BestEffort	
2	Source-IP, Dest-IP	Peak Rate, Min Rate	
Domain 3-2	Port:1		
3	Source-IP	Peak Rate, Min Rate	
Domain 3-3	Port		
4	Source-IP, Dest-IP	Peak Rate, Min Rate, Priorityt	
Domain 3-N	TOS, Port	Peak Rate, Min Rate, Priority BestEffort	

15

In TABLE 1, a subnetwork id (SN-id) represents an

identification of a domain 3-i. For example, the subnetwork id of the domain 3-1 in FIGS. 1 and 3 is 1, and likewise the SN-ids of the domains 3-2, 3-3, 3-N are respectively represented by 2, 3, 4.

5 And, as mentioned above, Supported Target Pattern indicates a target (kind) of guarantee of QoS, and Supported Service Quality indicates a quality that can be guaranteed to the target.

 Further in the Supported Target Pattern column,
 10 "Source-IP" and "Dest-IP" respectively represent a source IP address and a destination IP address; "Port", a port number of a source or destination terminal; "TOS", an IP service quality to be sent. And in the Supported Service Quality column, "Min Rate" represents a minimum rate to be
 15 guaranteed to the supported target pattern; "Peak Rate", a peak rate to be guaranteed. And "Priority" represents a policy control that can be made for the supported target pattern; "BestEffort" indicates that transmission is made with the best effort.

20 The actual meaning of "Min Rate" is: assuming that a requested QoS (rate) is 20 Mbps, basically the requested rate (20 Mbps) is guaranteed at minimum; but if there is room in the communication network, transmission might be made at a higher rate than 20 Mbps. On the other hand, the
 25 actual meaning of "Peak Rate" is: if a requested QoS (rate) is 20 Mbps, a rate of 20 Mbps is guaranteed; but even if there is room in the communication network, transmission

at any higher rate than 20 Mbps will not be made.

Also in TABLE 1, tagging information (Supported Tagging) indicates a domain 3-i to be combined with a possible supportable target pattern; for example, by
5 linking a domain 3-i with another domain including "Port:1" in the Supported Target Pattern" column, the information indicates that QoS guarantee can be made.

More specifically, the domain 3-2 (SN-id=2) originally does not support "Port" but will become enable
10 to support "Port" by linking with the domain 3-1 (SN-id=1). This Supported Tagging information can be adopted not only to "Port" but also to other Supported Target Patterns.

Namely, the management section 7 manages the tagging information, which discriminates combination of domains
15 3-i, as additional information so that discrimination of QoS capability in terms of combination of domains 3-i is facilitated, thus reducing time needed for selection of a candidate domain 3-i having a QoS capability such as to satisfy the required QoS capability and for controlling the
20 selected candidate domain 3-i.

When QoS capability management information is changed, the management section 7 is responsive to such notification to update the QoS capability information of the communication network 4 being managed by the management
25 section 7. Namely, when QoS that can be guaranteed is changed due to introduction of new facility into the domain 3-i, fault or heavy traffic.

For example, if a system (a number of units) composing the domain 3-3 that constitutes the communication network of FIG. 1 has changed to become able to support "TOS", such change is notified from EMS 2-3 to the management section 5 7 of NMS 1. In response to notification of this change, the management section 7 change the QoS capability layer NW view 42 and the end-to-end QoS capability NW view 43 to update the SN managed objects of TABLE 1.

The request reception section 8 receives a user's 10 request (QoS to be guaranteed) for QoS capability. The QoS request is managed by, for example, a non-illustrated service management system (SMS); for example, the user's requested QoS is notified from SMS to the request reception section 8 to start communication. This QoS request may be 15 directly inputted from the user's unit to start communication.

The selection and notification section 9 selects a candidate domain 3-i having such a QoS capability as to satisfy the requested QoS capability, which has been 20 received by the request reception section 8, by searching the end-to-end QoS capability NW view 42 in the management section 7, and then notifies such selection information to EMS 2-i corresponding to the selected candidate domain 3-i.

Assuming that a QoS request named "Source-IP (IP-a)", 25 "Dest-IP (IP-z), WFTP traffic (Port=20)", "Min rate (20Mbps)" has been made to the request reception section 8, a rate of 20 Mbps at minimum is guaranteed to FTP traffic

(Port=20) of a section from IP-a to IP-z.

Specifically, the function of this selection and notification section 9 is accomplished, as shown in FIG. 3, by both an end-to-end QoS policy provisioning performer (E-QPPP), which selects a candidate domain having a QoS capability such as to satisfy the requested QoS on an end-to-end basis, and a layer network QoS policy provisioning performer (LN-QPPP), which selects a plurality of domains 3-i if they exist in a common layer (technology), in the same manner as E-QPPP 13.

The selection and notification section 9 selects plural domains 3-i in view of a preset priority (policy) when selecting the domains 3-i as mentioned in the previous paragraph, and then notifies this selection to EMS 2-i corresponding to a higher-policy domain 3-i.

Specifically, the selection and notification section 8 previously selects plural candidate domains 3-i when selecting a domain 3-i having such a QoS capability so as to satisfy the requested QoS capability received by the request reception section 8, and notifies the preselected candidate domains 3-i to EMS 2-i corresponding to a first candidate domain 3-i. Upon receipt from EMS 2-i corresponding to the first candidate domain 3-i a response indicating that it unables to control the corresponding domain 3-i, then the selection and notification section 9 notifies the preselected candidate domains 3-i to EMS 2-i corresponding to a second candidate domain 3-i.

The above-mentioned policy, which is exemplified by
"use domain 3-2 (SN-id=2) with priority in high-speed
communication of a higher rate than 50 Mbps" and "use domain
3-3 (SN-id=3) with priority in communication of a rate lower
5 than 50 Mbps", may be set as desired by the carrier.

Following the policy set by the carrier, the
selection and notification section 9 selects, as the first
candidate, a combination of domains 3-1 (SN-id=1), 3-3
(SN-id=3), and 3-N (SN-id=4), and, as the second candidate,
10 a combination of domains 3-1 (SN-id=1), 3-2 (SN-id=2), 3-N
(SN-id=4), and then notifies this selection of candidates
to EMS 2-1, 2-3, 2-N corresponding to the first candidate
domains 3-1, 3-3, 3-N.

As a result, when it has received from EMS 2-1, 2-3,
15 2-n corresponding to the first candidates a response unable
to control at least one of the corresponding domains 3-1,
3-3, 3-N, the management section 7 notifies such selection
information to EMS 2-1, 2-2, 2-N of the second candidate
domains 3-1, 3-2, 3-N. In this case, the domains 3-i to
20 be selected are two combinations. Alternatively, when
three combinations are to be selected, selection and
notification of the domains 3-i may be made according to
the preset policy in the same manner as described above.

In the meantime, as shown in FIG. 3, EMS 2-i is
25 equipped with a control section 6-i for controlling the
corresponding domain 3-i based on the information notified
from the selection and notification section 9 of NMS 1. The

function of this control section 6-i is realized by SN-QPPP (Subnetwork Quality Policy Provisioning Performer) 15.

5 A single SN-QPPP 15 is provided for each and every layer of the corresponding domain 3-i and controls a set of units, which compose the corresponding domain 3-i, for every layer, performing QoS policy provisioning such as to satisfy the requested QoS.

10 The functions of NMS 1, and of the collection and notification section 5-i, the management section 7, the request reception section 8, the selection and notification section 9 and the control section 6-i of EMS 2-i, are realized as CPU (a non-illustrated computer) reads a program recorded in a recording medium, such as a disc device and CD-ROM, in NMS 1 and EMS 2-i to operate.

15 This program, which is usually recorded in, for example, CD-ROM, is installed into the disc device of the computer from CD-ROM to use. Therefore, each of the disc device and CD-ROM is regarded as a recording medium in which a program for realizing NMS 1 and EMS 2-i is recorded.

20 The operation of the communication network managing system thus constructed will now be described in detail:
(a) Description on configuration and updating of QoS capability management information at NMS 1

25 Firstly, at a domain 3-i, when the domain 3-i has been added to the system as a new unit or when QoS capability has been changed due to extension of facility, heavy traffic, etc., the corresponding EMS 2-i collects QoS capability

management information of the domain 3-i and notifies the collected QoS capability management information to NMS 1.

Then at NMS 1, as shown in FIG. 7, when the QoS capability management information has been received by the management section 7 (step A1), the QoS capability layer NW view 42 is configured/changed/deleted for every technology based on the notified QoS capability management information (step A2).

This configuration/change/deletion is then notified from LN-RC 11 to a higher-level, i.e., E-RC 12 (step A3). Upon receipt of this notice (step A4), E-RC 12 configures/-changes/deletes the end-to-end QoS capability NW view 43 of a united form of technologies in accordance with the configuration/change/deletion of the QoS capability layer NW view 42 (step A5). Thus in management section 7, the QoS capability layer NW view 42 and the end-to-end QoS capability NW view 43 is configured/changed/deleted so that latest QoS capability management information of the domain 3-i is automatically managed all the time.

(b) Description on QoS policy provisioning

Firstly, as shown in FIG. 8, when communication is about to start in an end-to-end basis, the request reception section 8 receives a user's QoS request (QoS policy provisioning performance request) named "guarantee a rate of 20 Mbps at minimum to FTP traffic (Port=20) of a section from IP-a to IP-z" (step B1). This QoS request is then received by E-QPPP 13.

Upon receipt of the QoS request, E-QPPP 13 starts searching domains 3-i such as to satisfy the QoS request (step B2). At that time, E-QPPP 13 searches, in an SN managed object shown in TABLE 1, a combination of domains 3-1, 3-2, 3-N and a combination of domains 3-1, 3-2, 3-N such that the supported target patterns is "Source IP", "Dest IP" and "Port" and the supported service quality of the last-named object is "Min Rate".

As the result of this searching, E-QPPP 13 discriminates whether an end-to-end domain structure (combination) such as to satisfy the QoS request exists (step B3). If no such end-to-end domain structure exists, then E-QPPP 13 makes an NG response to the request reception section 8 as the procedure takes NO route (step B15), whereupon the procedure terminates.

In the meantime, at step B3, if such end-to-end domain structure exists (if Yes route is selected), E-QPPP 13 provides an order of selection of domains in accordance with the policy of the carrier (step B4). As mentioned above, assuming that "use domain (3-2)(SN-id=2) with priority in high-speed communication of a higher rate than 50 Mbps" and "use domain (3-2)(SN-id=2) with priority in communication of a rate lower than 50 Mbps" is preset as the policy of the carrier, then E-QPPP 13 provides a first priority for the combination of domains 3-1, 3-3, 3-N and a second priority for the combination of domains 3-1, 3-2, 3-N.

Then E-QPPP 13 temporarily stores these candidate

that QoS provisioning is performed, whereupon the procedure terminates.

Further, at step B11, if none of EMS 2-1, 2-3, 2-N has issued an OK response, the procedure takes NO route to make a roll-back process to initialize the result of discrimination (step B16), and LN-QPPP 14 issues an NG response to E-QPPP 13 (step B17). In this case, at step B13, as the procedure takes NO route, E-QPPP 13 deletes the selected combination of candidate domains 3-1, 3-3, 3-N (step B18) and discriminates whether any other combination of candidate domains 3-i exists (step B19). If the result of this discrimination is positive, then the procedure takes NO route to restart from step B6. Namely, the same procedure is repeated from step B6 but for the second combination of candidate domains 3-1, 3-2, 3-N.

And at step B19, if the result of the last-named discrimination is negative, the procedure takes YES route so that E-QPPP 13 issues an NG response to the request reception section 8 (step B15), whereupon the procedure terminates.

Now assume that, as shown in FIG. 6, the domain 3-1 (access network (ATM)) of FIG. 1 is composed of a user unit, called ONU (Optical Network Unit), 20 and an Office unit, called OLT (Optical Line Terminator), 21. If the requested QoS is "guarantee a rate of 20 Mbps at minimum to FTP traffic (Port=20) of a section from IP-a to IP-z, and make transmission with best effort for the other communication",

EMS 2-1 receives such notice from the network manager (not shown in FIG. 6) in the above-mentioned manner, and sets a minimum rate guaranteed path called GFRPVC (Guaranteed Frame Rate Permanent Virtual Connection) between ONU 20 and OLT 21 of the access network (ATM).

ONU 20 takes 100/10BASE-T process for OP packet to be transmitted, and sets, in an IP filter, filter information to separately route the IP packet to GFRPVC with reference to IP address and Port field of the IP packet, and also converts data of this IP packet into ATM cells so that communication takes place through VCI=xx as shown in FIG. 6.

In the case of other requests, for example, if the request is different in "Dest-IP" or if the request is not for FTP traffic with "Dest-IP" being identical, communication takes place with best effort, i.e. at an unspecified bit rate (UBR), through VCI=yy. Thus inside the domain 3-1, a rate of 20 Mbps at minimum is guaranteed; for other requests, a network control satisfying the user's requested QoS such that transmission should be made with best effort (UBR).

The same network control takes place for the remaining domains 3-2, 3-N, and as a result, a rate of 20 Mbps at minimum is guaranteed to FTP traffic (Port=20) of a section from IP-a to IP-z.

According to the communication network managing system of the first embodiment, because NMS 1

00360" 23702360

concentratedly manages QoS capabilities of the domains 3-i notified from EMS 2-i (namely, manages regarding the domains 3-i as minimum managed units), and performs QoS policy provisioning in accordance with the user's requested QoS capability, it is possible to obtain a combination of domains 3-i satisfying the user's requested QoS capability on an end-to-end basis comfortably at high speed, so that the user's requested QoS can always be guaranteed precisely and quickly, irrespective of the domains 3-i through which communication traffic runs on an end-to-end basis, without managing QoS of the involved units, which constitute each domain 3-i, in terms of units.

Further, according to the communication network managing system of the first embodiment, since guarantee of the user's requested QoS is realized by an abstract information model, independent of the technology (topology), it is possible to readily cope with not only domains of technologies other than the above-mentioned technology, but also any added domain of a new technology.

(B) Second Embodiment:

FIG. 9 is a block diagram showing a modified communication network managing system according to a second embodiment of the present invention. The modified managing system of FIG. 9 is similar in structure to the managing system of the first embodiment except that it is equipped with a plurality of EMS 17-j ($j=1, 2, \dots, M$), and NMS 16 managing these EMS 17-j in correspondence with a

plurality of domains, such as an ISP (Internet Service
Provider) network, 18-1, 18-2, ..., 18-M (M is an integer
equal to or larger than 2) that constitute another
communication network (hereinafter called the second
5 communication network) 4' of a different carrier
(hereinafter called the second carrier).

It is now assumed that the second communication
network 4' of the second carrier is associated with the
communication network (hereinafter called the first
10 communication network) 4 of the own carrier (hereinafter
called the first carrier) by an agreement of the two
communication network companies so that the domains 18-1
of the second communication network 4' can be used in the
first communication network 4. Therefore, NMS 1 of the
15 second embodiment concentratedly manages QoS capabilities
of the domains 3-i constituting the first communication
network 4 of the first carrier, but also QoS capabilities
of the domains 18-1 constituting the second communication
network 4' of the second carrier, in view of QoS capability
20 management information of the domains 18-1.

Specifically, in the modified communication network
managing system, as shown in FIG. 10, LN-RC 11 of a
management section 7 receives notice of QoS capability
management information of the domains 18-1 from NMS 16 of
25 the second communication network 4' of the second carrier,
and configures a QoS capability layer NW view 42' in view
of the QoS capability of the domains 18-1 of the second

carrier in addition to the QoS capability management information of the domains 3-i of the first carrier. Based on the QoS capability layer NW view 42', E-RC 12 configures an end-to-end QoS capability NW view 43' also in view of
5 the QoS capability management information of the domain 18-1.

Alternatively, the QoS capability management information of the domains 18-1 of the second communication network 4' of the second carrier may be notified from EMS
10 17-1 that is provided in correspondence to the domains 18-1.

This end-to-end QoS capability NW view 43' is managed by linking the SN managed object for the domains 3-i of the first communication network 4 first carrier (TABLE 1) with the SN managed object for the domains 18-1 of the second
15 communication network 4' of the second carrier, as shown in TABLE 2 below.

TABLE 2

SN MANAGED OBJECTS

SN-id	Supported Target Pattern	Supported Service Quality	Supported Tagging
1 Domain 3-1	Source-IP, Dest-IP	Peak Rate, Min Rate, BestEffort	Port:1
	TOS, Port	Peak Rate, Min Rate, Priority, BestEffort	
2 Domain 3-2	Source-IP, Dest-IP	Peak Rate, Min Rate	
	Port:1		
3 Domain 3-3	Source-IP	Peak Rate, Min Rate	
	Port		
4 Domain 3-N	Source-IP, Dest-IP	Peak Rate, Min Rate, Priority	
	TOS, Port	Peak Rate, Min Rate, Priority BestEffort	
5 Domain 18-1	Source-IP, Dest-IP	Peak Rate, Min Rate	
	Port	Peak Rate	

5 In an alternative form, this management may be realized in a concentrated manner in which the domains 18-1 of the second carrier are united with the domains 3-i of the first carrier as the common SN managed objects.

10 Now assuming that the requested QoS capability received by a request reception section 8 is "guarantee a rate of 20 Mbps at minimum for FTP traffic of a section from IP-a to IP-z" likewise in the first embodiment, it would become possible to select, as such combinationw of domains as to satisfy the required QoS, the first combination of

domains 3-1, 3-3, 3-N and the second combination of domains 3-1, 3-2, 3-N as well as another, mixed combination of domains 3-1, 18-1, 3-N including the domains 18-1 of the second communication network 4' of the second carrier.

5 Further, assume that, a policy named "do not use the domains 18-1 of the second carrier unless no other candidates are available", in addition to the above-mentioned policies "use domain 3-2 (SN-id=2) with priority in high-speed communication of a higher rate than
10 50 Mbps" and "use domain 3-3 (SN-id=3) with priority in communication of a rate lower than 50 Mbps". In this case, the first, second and third candidates would be a combination of domains 3-1, 3-3, 3-N, a combination of domains 3-1, 3-2, 3-N, and a combination of domains 3-1,
15 18-1, 3-N; therefore, when either of the first and second candidates cannot be selected, then the third candidate containing the domains 18-1 of the second carrier is selected as domains as the objects whom QoS policy provisioning is to be performed.

20 The operation of the modified communication network managing system according to the second embodiment is different from that of the first embodiment in that, at steps B2, B3 of the flow diagram shown in FIG. 8, searching of domains in view of the QoS capability management
25 information for the domains 18 of the second carrier is performed. In the second embodiment, the remaining operations (including the updating procedure of the QoS

capability layer NW view 42' and the end-to-end QoS capability NW view 43') are identical with the operation described in connection with the first embodiment (FIGS. 7 and 8).

5 According to the modified communication network managing system of the second embodiment, since NMS 1 sets the QoS policy provisioning in view of the QoS capability management information also for the domains 18-1 of the second carrier, it is possible not only to offer the same
10 advantageous results as those of the first embodiment, but to choose the end-to-end communication traffic including the domains 18-1 of the second carrier, realizing a more efficient management of communication network.

(C) Alternatives:

15 In the first and second embodiments, the domains 3-1, 3-2, . . . , 3-N constituting the communication network 4 are constructed in a multi-technology form. Alternatively, they may be constructed in a single-technology form, such as an access network (ATM). In the case of this alternative,
20 since the end-to-end QoS capability can be grasped by the QoS capability layer SN VIEW 42 (42') configured by LN-RC 11, E-RC 12 would become needless, so E-QPPP 13 also would become needless.

 Further, in the second embodiment, among the domains
25 of the second communication network 4' of the second carrier, the domain for whom the first communication network 4 of the first carrier can be used is only the domain 18-1.

Alternatively, all or part of the remaining domains 18-2, 18-3, ..., 18-N that constitute the second communication network 4' may be used. In another alternative, two or more communication networks of different carriers to be
5 considered by NMS 1 may exist.

The present invention should by no means be limited to the individual illustrated examples, and various changes or modifications may be suggested without departing from the gist of the inventive concept.

What is claimed is:

1 1. A system for managing a communication network
2 composed of a plurality of subnetworks, comprising:
3 a plurality of element managers provided one for each
4 of the plural subnetworks; and
5 a network manager accommodating said plural element
6 managers for concentrated management thereof;
7 each of said plural element managers having a
8 collection and notification section for collecting QoS
9 (Quality of Service) capability management information on
10 the corresponding element manager and notifying said
11 network manager of the collected QoS capability management
12 information;
13 said network manager having
14 a management section for concentratedly
15 managing various QoS capabilities of the whole
16 communication network, based on the QoS capability
17 management information collected and notified by the
18 individual element managers, and
19 a request reception section for receiving a
20 request for a target QoS capability, and
21 a selection and notification section for
22 selecting a candidate subnetwork having a QoS
23 capability such as to satisfy the target QoS
24 capability, for which the request has been received
25 by said request reception section, based on the

26 various QoS capabilities being managed by said
27 management section, and for notifying said element
28 manager corresponding the selected candidate
29 subnetwork of selection information indicating that
30 the candidate subnetwork has been selected;
31 each said element manager further having a control
32 section for controlling the corresponding subnetwork based
33 on the selection information notified by said selection and
34 notification section of said network manager.

1 2. A system for managing a communication network
2 composed of a plurality of subnetworks, comprising:

3 a plurality of element managers provided one for each
4 of the plural subnetworks for individual management
5 thereof; and

6 a network manager accommodating said plural element
7 managers for concentrated management thereof;

8 each of said plural element managers having a
9 collection and notification section for collecting QoS
10 (Quality of Service) capability management information on
11 the corresponding element manager and notifying said
12 network manager of the collected QoS capability management
13 information;

14 said network manager having
15 a management section for concentratedly managing various
16 QoS capabilities of the whole communication network, based
17 on the QoS capability management information collected and

18 notified by the individual element managers.

1 3. An element manager for use in a communication
2 network managing system, which manages a communication
3 network composed of a plurality of subnetworks and includes
4 a plurality of element managers corresponding to the plural
5 subnetworks and a network manager accommodating the plural
6 element managers, said element manager comprising:

7 a collection and notification section for collecting
8 QoS (Quality of Service) capability management information
9 to be used in managing the corresponding subnetwork, and
10 for notifying the network manager of the collected QoS
11 capability management information; and

12 a control section for controlling the corresponding
13 subnetwork based on information which is obtained by the
14 network manager having a function of concentratedly
15 managing QoS capabilities of the communication network
16 based on said QoS capability management information
17 collected and notified by said collection and notification
18 section and which is notified from the network manager on
19 the candidate subnetwork having a QoS capability such as
20 to satisfy a target QoS capability for the corresponding
21 subnetwork.

1 4. An element manager for use in a communication
2 network managing system, which manages a communication
3 network composed of a plurality of subnetworks and includes

18 has been received by said request reception section, based
19 on the various QoS capabilities being managed by said
20 management section, and for notifying the element manager
21 corresponding to the selected subnetwork of selection
22 information that the candidate subnetwork has been
23 selected.

1 6. A network manager for use in a communication
2 network managing system which manages a communication
3 network composed of a plurality of subnetworks and includes
4 a plurality of element managers corresponding to the plural
5 subnetworks, and a network manager accommodating the plural
6 element managers,

7 wherein said network manager has a management section
8 for concentratedly managing various QoS (Quality of
9 Service) capabilities of the whole communication network,
10 based on QoS capability management information of the
11 corresponding subnetworks, which information has been
12 collected and notified by the individual element managers.

1 7. A network manager for use in a communication
2 network managing system according to claim 5, wherein said
3 management section is constructed to concentratedly manage
4 the various QoS capabilities of said communication network
5 and those of another communication network independent of
6 the last-named communication network in view of also QoS
7 capability management information of other subnetworks

8 that constitute said another communication network.

1 8. A network manager for use in a communication
2 network managing system according to claim 5, wherein said
3 management section is constructed to manage supported
4 tagging, as additional information, for discrimination on
5 combination of the subnetworks.

1 9. A network manager for use in a communication
2 network managing system according to claim 5, wherein said
3 management section is constructed to update the various QoS
4 capabilities of the communication network when said QoS
5 capability management information is updated.

1 10. A network manager for use in a communication
2 network managing system according to claim 5, wherein said
3 selection and notification section is constructed to
4 previously select two or more of the subnetworks when
5 selecting the candidate subnetworks having communication
6 QoS capabilities such as to individually satisfy the target
7 QoS capability, for which the request has been received by
8 said request reception section, to firstly notify one
9 element manager, corresponding to a first one of the
10 candidate subnetworks, of the previous selection of the
11 plural subnetworks and secondly notify another element
12 manager, corresponding to a second one of the candidate
13 subnetworks, of unable information that the corresponding

14 subnetwork cannot be controlled, upon receipt of the unable
15 information as a response from the element manager
16 corresponding to the first candidate subnetwork.

1 11. A network manager for use in a communication
2 network managing system according to claim 5, wherein said
3 selection and notification section is constructed to select
4 two or more of the subnetworks according to preset
5 priorities when selecting the candidate subnetworks having
6 QoS capabilities such as to individually satisfy the target
7 QoS capability, for which the response has been received
8 by said request reception section, and to notify one element
9 manager, corresponding to a higher-priority one of the
10 candidate subnetworks, of the selection.

1 12. A computer-readable recording medium in which
2 a program is recorded for instructing a computer to be used
3 in a communication network management system including a
4 plurality of element managers corresponding to a plurality
5 of subnetworks that constitute a communication network, and
6 a network manager accommodating the plural element managers,
7 wherein said program instructs said computer to function
8 as the following:

9 collecting and notifying means for collecting QoS
10 (Quality of Service) capability management information on
11 the corresponding element manager and notifying said
12 network manager of the collected QoS capability management

US 2008/0183030

13 information; and

14 control means for controlling the corresponding
15 subnetwork based on information which is obtained by the
16 network manager having a function of concentratedly
17 managing various QoS capabilities of the whole
18 communication network based on said QoS capability
19 management information collected and notified by said
20 collecting and notifying means and which is notified from
21 the network manager on the candidate subnetwork having a
22 QoS capability such as to satisfy a target QoS capability
23 for the individual subnetwork.

1 13. A computer-readable recording medium in which
2 a program is recorded for instructing a computer to be used
3 in a communication network managing system including a
4 plurality of element managers corresponding to a plurality
5 of subnetworks that constitute a communication network, and
6 a network manager accommodating the plural element
7 managers,

8 wherein said program instructs said computer to
9 function as collecting and notifying means for collecting
10 various QoS capability management information on the
11 individual element managers and notifying said network
12 manager of the collected QoS capability management
13 information.

1 14. A computer-readable recording medium in which

4 plurality of element managers corresponding to a plurality
5 of subnetworks that constitute a communication network, and
6 a network manager accommodating the plural element
7 managers,

8 wherein said program instructs said computer to
9 function as managing means for concentratedly managing
10 various QoS (Quality of Service) capabilities of the
11 network, based on QoS capability management information of
12 the corresponding subnetworks, which information has been
13 collected and notified by the individual element managers.

1 16. A network manager for use in a communication
2 network managing system according to claim 7, wherein said
3 management section is constructed to manage supported
4 tagging, as additional information, for discrimination on
5 combination of the subnetworks.

1 17. A network manager for use in a communication
2 network managing system according to claim 16, wherein said
3 management section is constructed to update the various QoS
4 capabilities of the communication network when said QoS
5 capability management information is updated.

1 18. A network manager for use in a communication
2 network managing system according to claim 8, wherein said
3 management section is constructed to update the various QoS
4 capabilities of the communication network when said QoS

5 capability management information is updated.

1 19. A network manager for use in a communication
2 network managing system according to claim 6, wherein said
3 management section is constructed to concentratedly manage
4 the various QoS capabilities of said communication network
5 and those of another communication network independent of
6 the last-named communication network in view of also QoS
7 capability management information of other subnetworks
8 that constitute said another communication network.

1 20. A network manager for use in a communication
2 network managing system according to claim 19, wherein said
3 management section is constructed to manage supported
4 tagging, as additional information, for discrimination on
5 combination of the subnetworks.

1 21. A network manager for use in a communication
2 network managing system according to claim 20, wherein said
3 management section is constructed to update the various QoS
4 capabilities of the communication network when said QoS
5 capability management information is updated.

1 22. A network manager for use in a communication
2 network managing system according to claim 6, wherein said
3 management section is constructed to manage supported
4 tagging, as additional information, for discrimination on

5 combination of the subnetworks.

1 23. A network manager for use in a communication
2 network managing system according to claim 22, wherein said
3 management section is constructed to update the various QoS
4 capabilities of the communication network when said QoS
5 capability management information is updated.

1 24. A network manager for use in a communication
2 network managing system according to claim 6, wherein said
3 management section is constructed to update the various QoS
4 capabilities of the communication network when said QoS
5 capability management information is updated.

ABSTRACT OF THE DISCLOSURE

In a communication network managing system, at a network manager, a management section concentratedly
5 manages QoS (Quality of Service) capability management information from element managers (i represents an integer selected from 1 through N where N is an integer equal or larger than 2), a request reception section receives a request for a target QoS capability, and a selection and
10 notification section selects a candidate subnetwork such as to satisfy the target QoS capability for which the request has been received by the request reception section, and notifies the corresponding element managers of information about the selection. At the individual
15 element manager, based on the selection information from the selection and notification section of the network manager, a control section controls the corresponding subnetwork.

FIG. 2

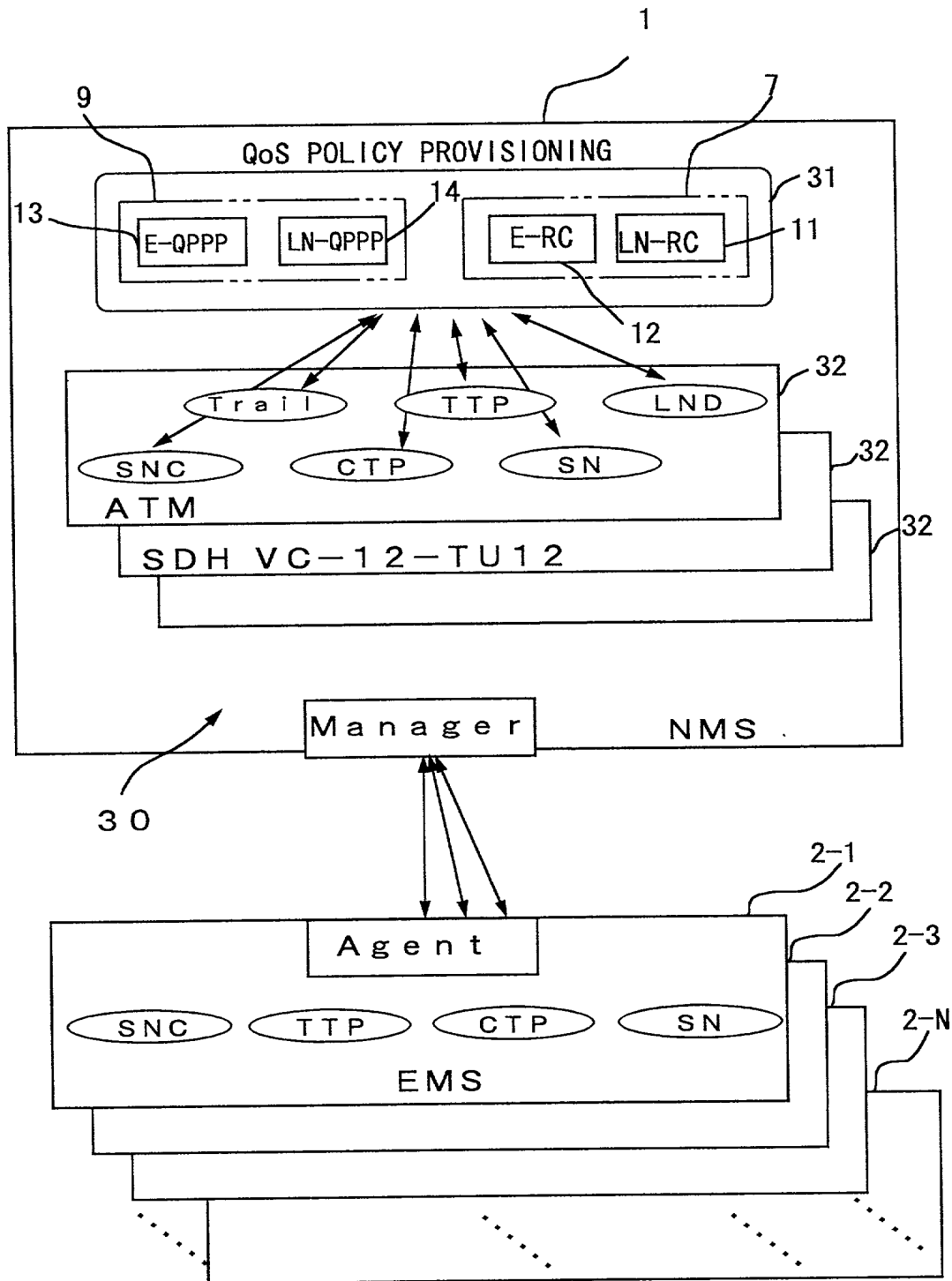

MANAGEMENT OBJECT

□ : FUNCTION OBJECT

○ : INFORMATION OBJECT

FIG. 3

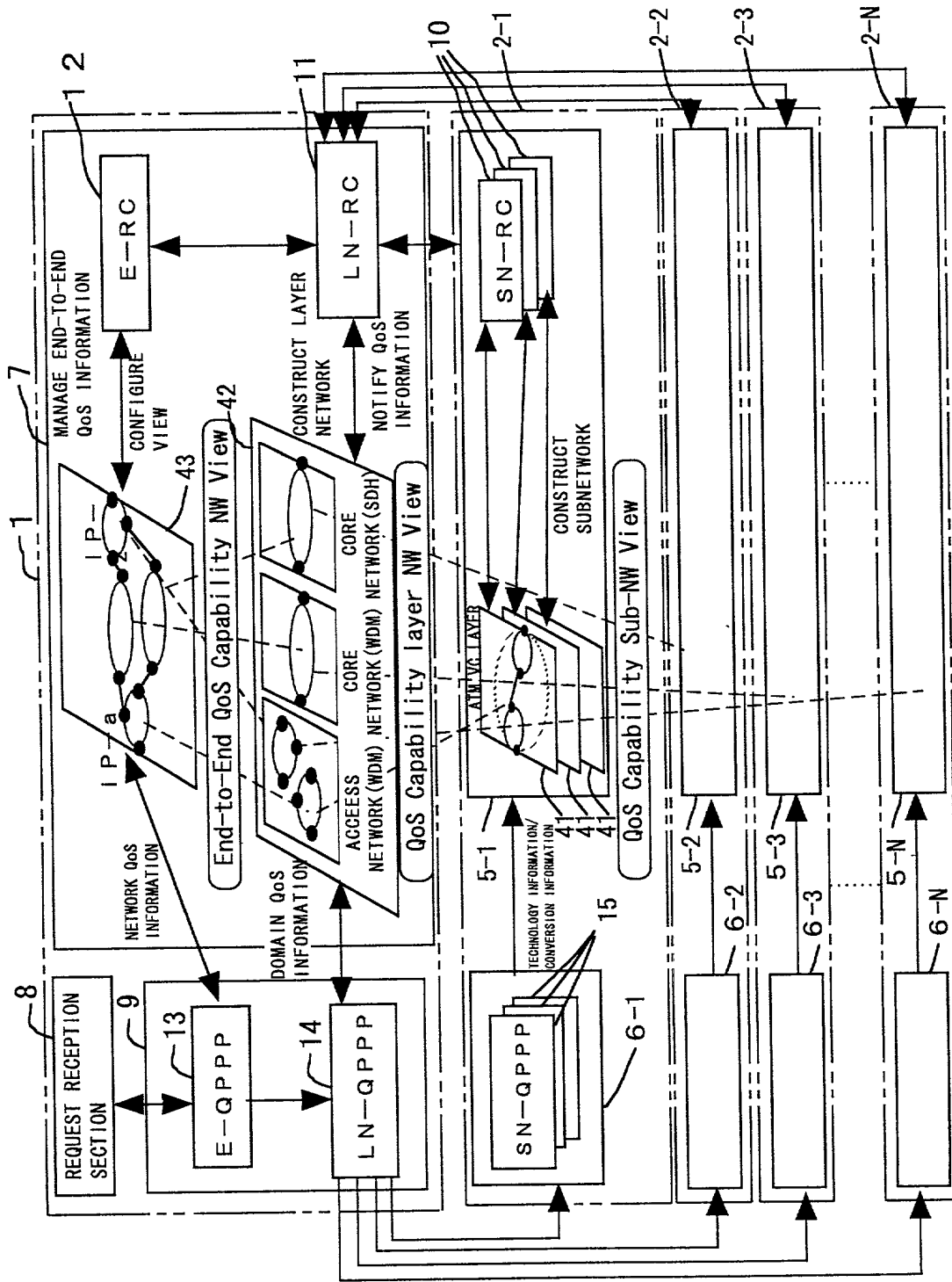

FIG. 6

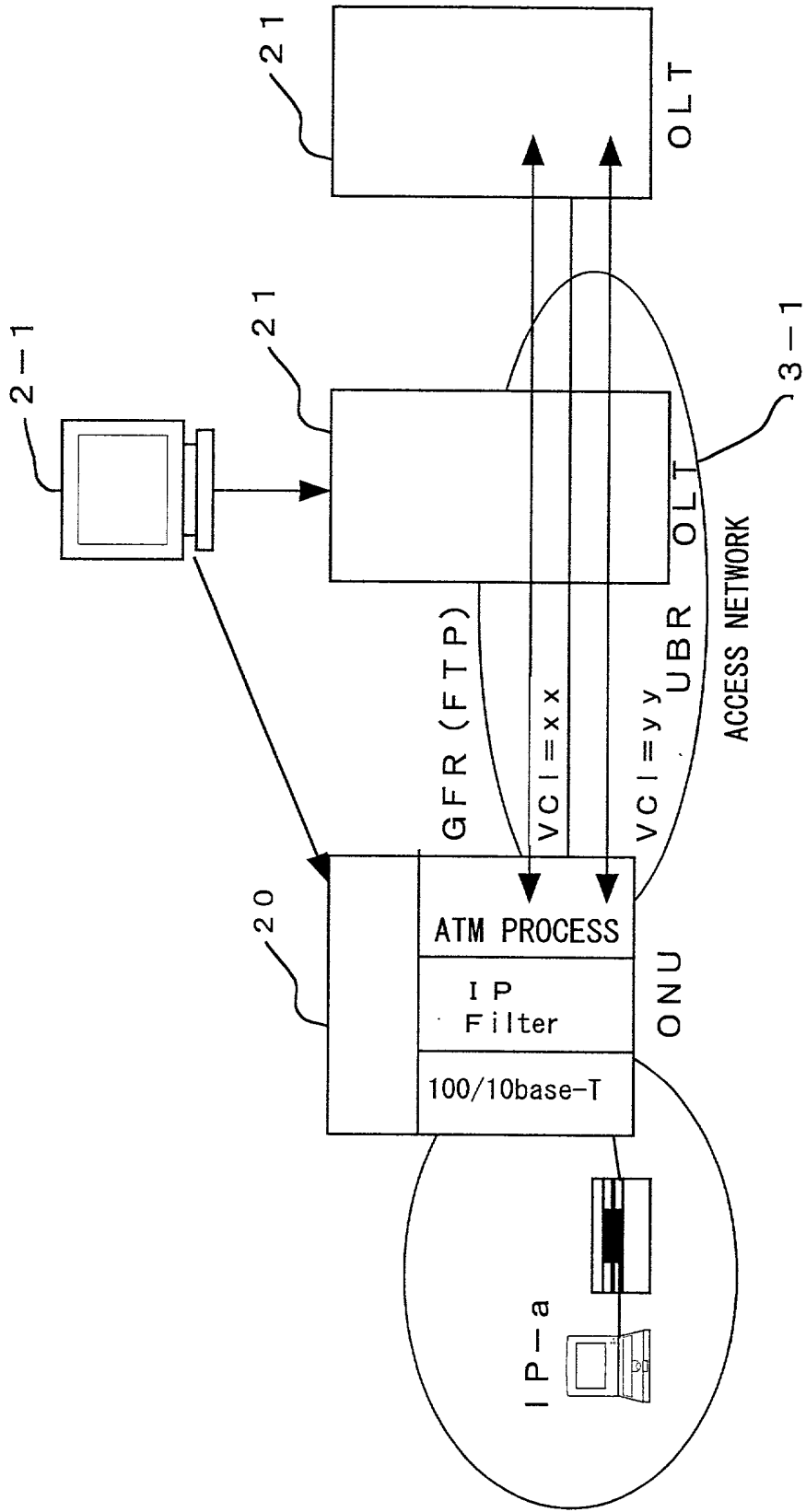
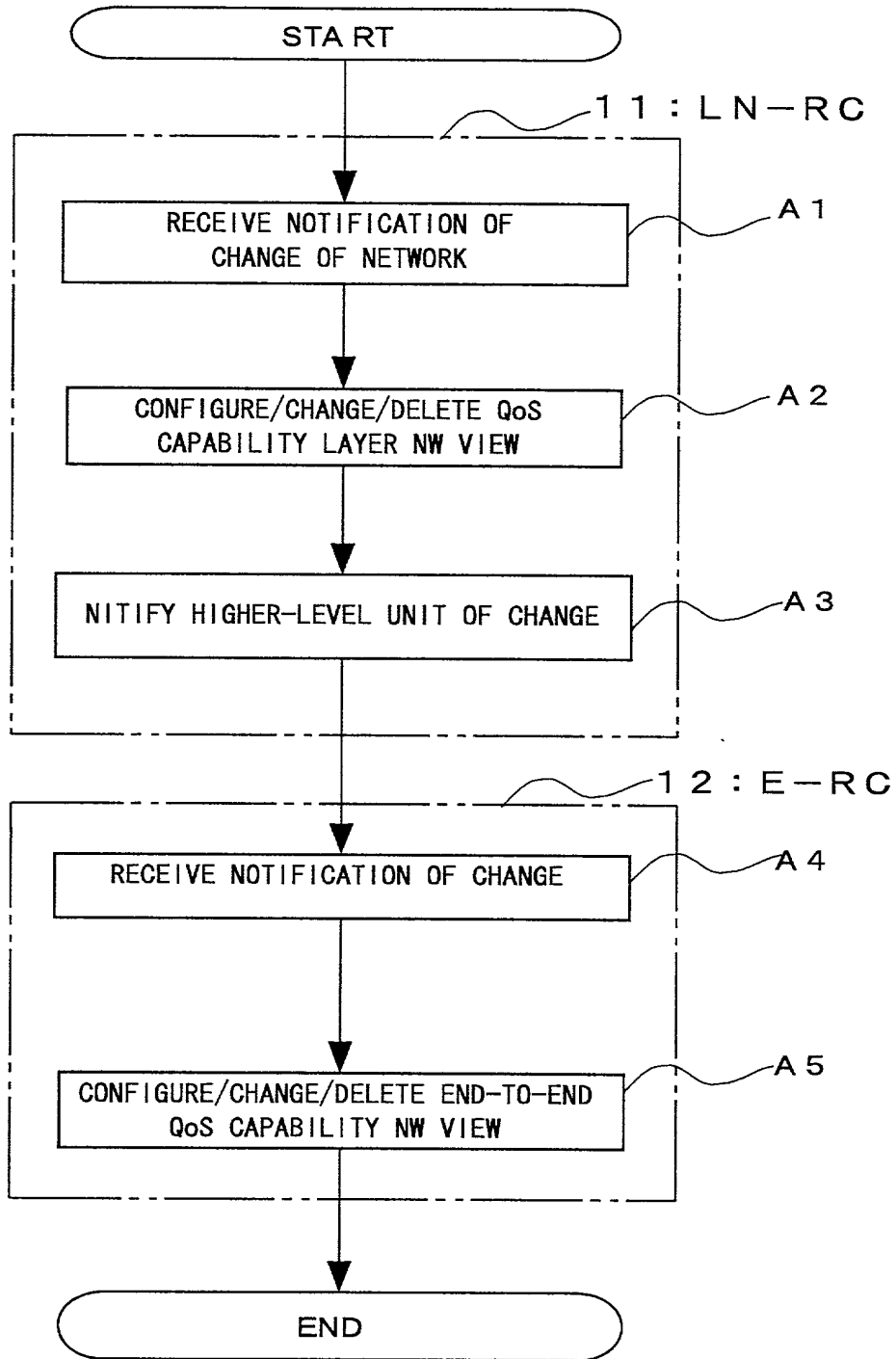

FIG. 7



Copyright © 2006, Cisco Systems, Inc.

FIG. 8

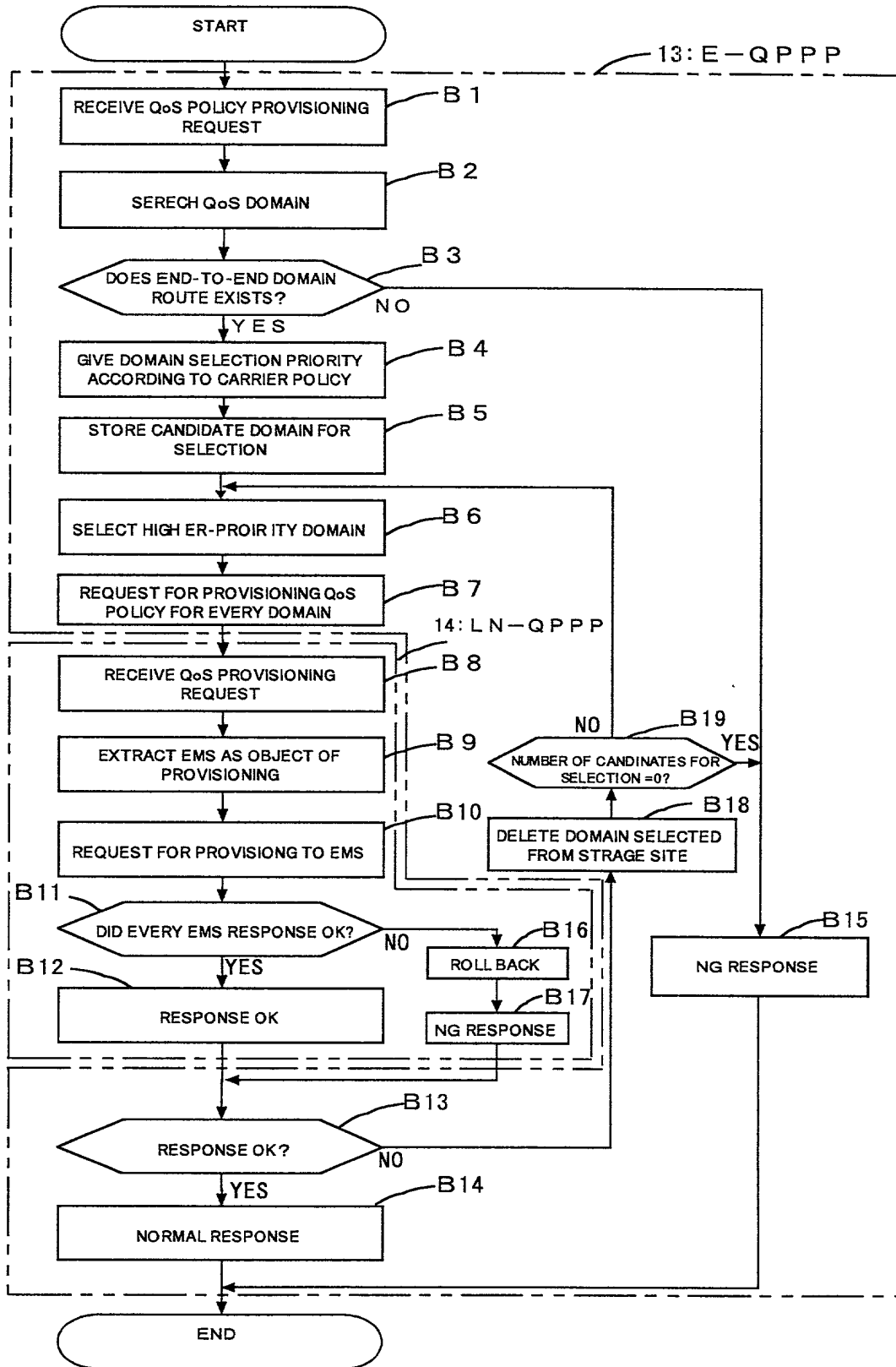
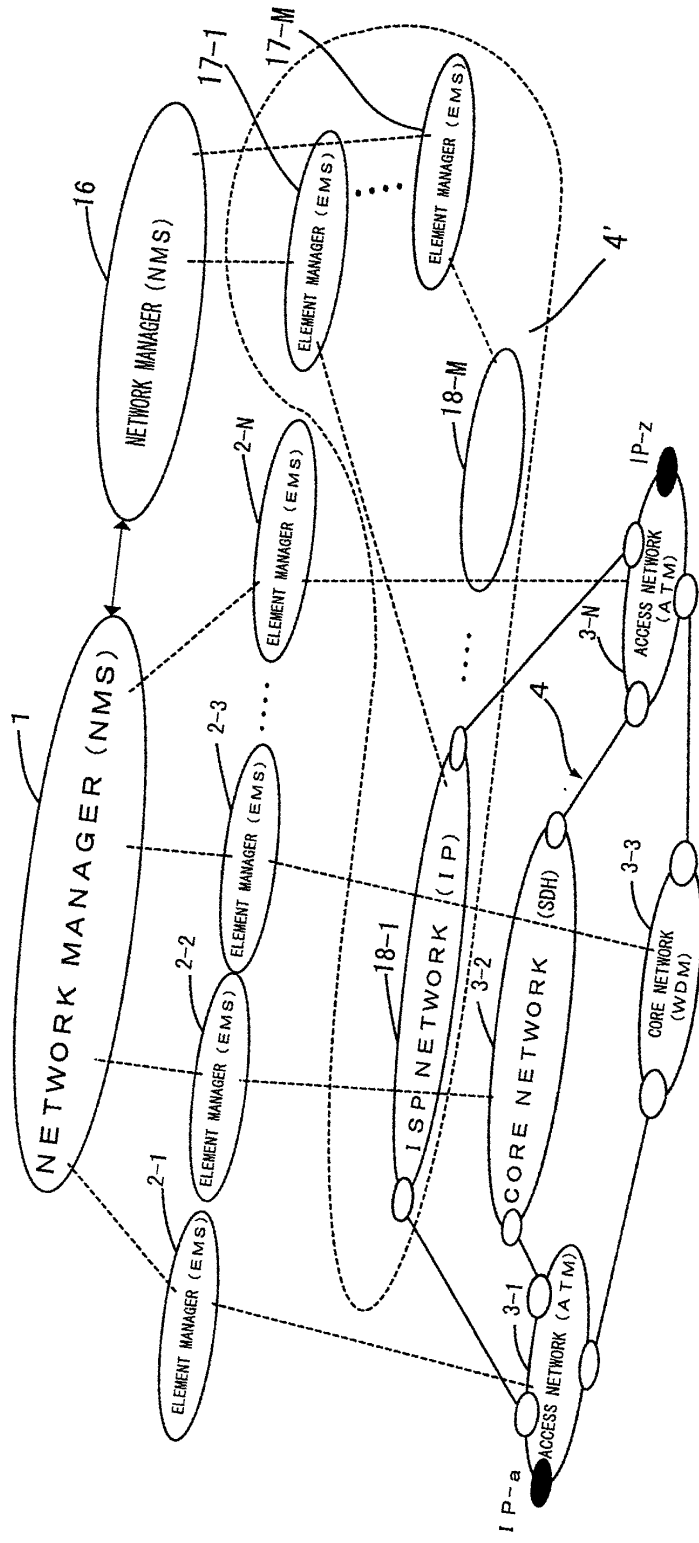

FIG. 9



Under the Paperwork Reduction Act of 1995, no persons are required to respond to a collection of information unless it displays a valid OMB control number.

Declaration and Power of Attorney For Patent Application

特許出願宣言書及び委任状

Japanese Language Declaration

日本語宣言書

下記の氏名の発明者として、私は以下の通り宣言します。

As a below named inventor, I hereby declare that:

私の住所、私書箱、国籍は下記の私の氏名の後に記載された通りです。

My residence, post office address and citizenship are as stated next to my name.

下記の名称の発明に関して請求範囲に記載され、特許出願している発明内容について、私が最初かつ唯一の発明者（下記の氏名が一つの場合）もしくは最初かつ共同発明者であると（下記の名称が複数の場合）信じています。

I believe I am the original, first and sole inventor (if only one name is listed below) or an original, first and joint inventor (if plural names are listed below) of the subject matter which is claimed and for which a patent is sought on the invention entitled

COMMUNICATION NETWORK MANAGING SYSTEM,
ELEMENT AND NETWORK MANAGERS THEREFOR,
AND COMPUTER-READABLE RECORDING MEDIUM IN
WHICH COMMUNICATION NETWORK MANAGING
PROGRAM IS RECORDED

上記発明の明細書（下記の欄でX印がついていない場合は、本書に添付）は、

the specification of which is attached hereto unless the following box is checked:

__月__日に提出され、米国出願番号または特許協定条約国際出願番号を_____とし、
 （該当する場合）_____に訂正されました。

was filed on _____
 as United States Application Number or
 PCT International Application Number
 _____ and was amended on
 _____ (if applicable).

私は、特許請求範囲を含む上記訂正後の明細書を検討し、内容を理解していることをここに表明します。

I hereby state that I have reviewed and understand the contents of the above identified specification, including the claims, as amended by any amendment referred to above.

私は、連邦規則法典第37編第1条56項に定義されるとおり、特許資格の有無について重要な情報を開示する義務があることを認めます。

I acknowledge the duty to disclose information which is material to patentability as defined in Title 37, Code of Federal Regulations, Section 1.56.

Under the Paperwork Reduction Act of 1995, no persons are required to respond to a collection of information unless it displays a valid OMB control number.

Japanese Language Declaration
(日本語宣言書)

私は、米国法典第35編119条(a)-(d)項又は365条(b)項に基づき下記の、米国外の国の少なくとも一カ国を指定している特許協力条約365(a)項に基づき国際出願、又は外国での特許出願もしくは発明者証の出願についての外国優先権をここに主張するとともに、優先権を主張している、本出願の前に出願された特許または発明者証の外国出願を以下に、枠内をマークすることで、示しています。

I hereby claim foreign priority under Title 35, United States Code, Section 119(a)-(d) or 365(b) of any foreign application(s) for patent or inventor's certificate, or 365(a) of any PCT International application which designated at least one country other than the United States, listed below and have also identified below, by checking the box, any foreign application for patent or inventor's certificate, or PCT International application having a filing date before that of the application on which priority is claimed.

Priority Not Claimed
優先権主張なし

Patent Application
Prior Foreign Application(s)

外国での先行出願

No. HEI 11-322736 Japan
(Number) (Country)
(番号) (国名)

12/11/1999
(Day/Month/Year Filed)
(出願年月日)

(Number) (Country)
(番号) (国名)

(Day/Month/Year Filed)
(出願年月日)

私は、第35編米国法典119条(e)項に基づいて下記の米国外の特許出願規定に記載された権利をここに主張いたします。

I hereby claim the benefit under Title 35, United States Code, Section 119(e) of any United States provisional application(s) listed below.

(Application No.) (Filing Date)
(出願番号) (出願日)

(Application No.) (Filing Date)
(出願番号) (出願日)

私は、下記の米国法典第35編120条に基づいて下記の米国外の特許出願に記載された権利、又は米国外を指定している特許協力条約365条(c)に基づき権利をここに主張します。また、本出願の各請求範囲の内容が米国法典第35編112条第1項又は特許協力条約で規定された方法で先行する米国外の特許出願に開示されていない限り、その先行米国外出願書提出日以降で本出願書の日本国内または特許協力条約国際提出日までの期間中に入手された、連邦規則法典第37編1条56項で定義された特許資格の有無に関する重要な情報について開示義務があることを認識しています。

I hereby claim the benefit under Title 35, United States Code, Section 120 of any United States application(s), or 365(c) of any PCT International application designating the United States, listed below and, insofar as the subject matter of each of the claims of this application is not disclosed in the prior United States or PCT International application in the manner provided by the first paragraph of Title 35, United States Code Section 112, I acknowledge the duty to disclose information which is material to patentability as defined in Title 37, Code of Federal Regulations, Section 1.56 which became available between the filing date of the prior application and the national or PCT International filing date of application.

(Application No.) (Filing Date)
(出願番号) (出願日)

(Status: Patented, Pending, Abandoned)
(現況: 特許許可済、係属中、放棄済)

(Application No.) (Filing Date)
(出願番号) (出願日)

(Status: Patented, Pending, Abandoned)
(現況: 特許許可済、係属中、放棄済)

私は、私自身の知識に基づいて本宣言書中で私が行なう表明が真実であり、かつ私の入手した情報と私の信じることに基づき表明が全て真実であると信じていること、さらに故意になされた虚偽の表明及びそれと同等の行為は米国法典第18編第1001条に基づき、罰金または拘禁、もしくはその両方により処罰されること、そしてそのような故意による虚偽の表明を行えば、出願した、又は既に許可された特許の有効性が失われることを認識し、よってここに上記のごとく宣誓を致します。

I hereby declare that all statements made herein of my own knowledge are true and that all statements made on information and belief are believed to be true; and further that these statements were made with the knowledge that willful false statements and the like so made are punishable by fine or imprisonment, or both, under Section 1001 of Title 18 of the United States Code and that such willful false statements may jeopardize the validity of the application or any patent issued thereon.

Under the Paperwork Reduction Act of 1995, no persons are required to respond to a collection of information unless it displays a valid OMB control number.

Japanese Language Declaration
 (日本語宣言書)

委任状： 私は下記の発明者として、本出願に関する一切の手続きを米特許商標局に対して遂行する弁理士または代理人として、下記の者を指名いたします。(弁護士、または代理人の氏名及び登録番号を明記のこと)

POWER OF ATTORNEY: As a named inventor, I hereby appoint the following attorney(s) and/or agent(s) to prosecute this application and transact all business in the Patent and Trademark Office connected therewith (list name and registration number)

書類送付先

Aaron B. KARAS, Reg. No. 18,923; Samson HELFGOTT, Reg. No. 23,072 and Leonard COOPER Reg. No.27,625
 Send Correspondence to:
 HELFGOTT & KARAS, P.C.
 Empire State Building, 60th Floor
 New York, New York 10118
 United States of America

直接電話連絡先： (名前及び電話番号)

Direct Telephone Calls to: (name and telephone number)
 Helfgott & Karas, P.C.
 (212) 643-5000

唯一または第一発明者名	Full name of sole or first inventor Takao OGURA		
発明者の署名	日付	Inventor's signature <i>Takao Ogura</i>	Date September 8, 2000
住所	Residence Kawasaki, Japan		
国籍	Citizenship Japanese		
私書箱	Post Office Address c/o FUJITSU LIMITED, 1-1, Kamikodanaka 4-chome, Nakahara-ku, Kawasaki-shi, Kanagawa 211-8588 Japan		
第二共同発明者	Full name of second joint inventor, if any Kenichi FUKUDA		
第二共同発明者	日付	Second inventor's signature <i>Kenichi Fukuda</i>	Date September 8, 2000
住所	Residence Kawasaki, Japan		
国籍	Citizenship Japanese		
私書箱	Post Office Address c/o FUJITSU LIMITED, 1-1, Kamikodanaka 4-chome, Nakahara-ku, Kawasaki-shi, Kanagawa 211-8588 Japan		

(第三以降の共同発明者についても同様に記載し、署名をすること)

(Supply similar information and signature for third and subsequent joint inventors.)

第三共同発明者		Full name of third joint inventor, if any Makoto MINOURA
第三共同発明者	日付	Third inventor's signature Date <i>Makoto Minoura</i> September 8, 2000
住 所		Residence Kawasaki, Japan
国 籍		Citizenship Japanese
私書箱		Post Office Address c/o FUJITSU LIMITED, 1-1, Kamikodanaka 4-chome, Nakahara-ku, Kawasaki-shi, Kanagawa 211-8588 Japan
第四共同発明者		Full name of fourth joint inventor, if any Hitoshi UENO
第四共同発明者	日付	Fourth inventor's signature Date <i>Hitoshi Ueno</i> September 8, 2000
住 所		Residence Kawasaki, Japan
国 籍		Citizenship Japanese
私書箱		Post Office Address c/o FUJITSU LIMITED, 1-1, Kamikodanaka 4-chome, Nakahara-ku, Kawasaki-shi, Kanagawa 211-8588 Japan
第五共同発明者		Full name of fifth joint inventor, if any Kohei ISEDA
第五共同発明者	日付	Fifth inventor's signature Date <i>Kohei Iseda</i> September 8, 2000
住 所		Residence Kawasaki, Japan
国 籍		Citizenship Japanese
私書箱		Post Office Address c/o FUJITSU LIMITED, 1-1, Kamikodanaka 4-chome, Nakahara-ku, Kawasaki-shi, Kanagawa 211-8588 Japan
第六共同発明者		Full name of sixth joint inventor, if any
第六共同発明者	日付	Sixth inventor's signature Date
住 所		Residence
国 籍		Citizenship
私書箱		Post Office Address

(第七以降の共同発明者についても同様に
記載し、署名をすること)

(Supply similar information and signature for
seventh and subsequent joint inventors.)

THE UNITED STATES PATENT AND TRADEMARK OFFICE

In re the Application of: **Takao OGURA et al.**

Filed : **Concurrently herewith**

For : **COMMUNICATION NETWORK MANAGING
SYSTEM, ELEMENT AND NETWORK
MANAGERS THEREFOR, AND COMPUTER-
READABLE RECORDING MEDIUM IN WHICH
COMMUNICATION NETWORK MANAGING
PROGRAM IS RECORDED**

Serial No. : **Concurrently herewith**

September 26, 2000

Assistant Commissioner of Patents
Washington, D.C. 20231

SUB-POWER OF ATTORNEY

S I R:

I, Aaron B. Karas, Reg. No. 18,923 attorney of record herein, do hereby grant a sub-power of attorney to Linda S. Chan, Reg. No. 42,400, Jacqueline M. Steady, Reg. No., 44,354, Harris A. Wolin, Reg. No. 39,432 and Brian S. Myers, Reg. No. 46,947 to act and sign in my behalf in the above-referenced application.

Respectfully submitted,

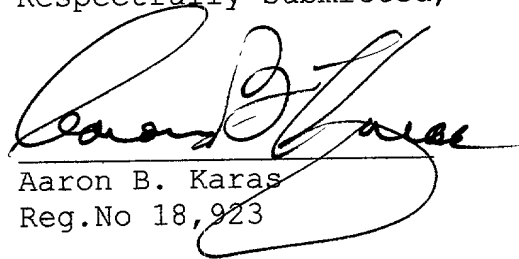
Aaron B. Karas
Reg.No 18,923

HELFGOTT & KARAS, P.C.
60th FLOOR
EMPIRE STATE BUILDING
NEW YORK, NY 10118
DOCKET NO.:FUJS17.791
LHH:power

Filed by Express Mail
(Receipt No. 1532335486US)
on 9/26/00
pursuant to 37 C.F.R. 1.10.
by Jen2602

Any fee due with this paper, not fully covered by an enclosed check, may be charged on Deposit Acct. No. 08-1634